

PROFILATI IN ALLUMINIO PER SPONDE, FURGONI E PIANALI

PROFILATI IN ALLUMINIO PER SPONDE

Profili ad incastro per sponde da 25 mm

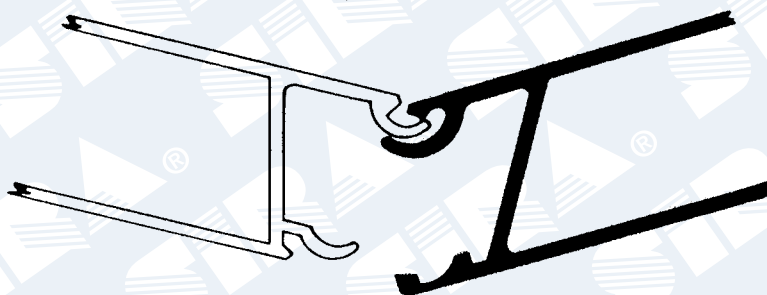

SERIE TS

Profili superiori

V 1044

Kg/ml	2,254
Lunghezza	7,5 m
Lunghezza	6,6 m
Lunghezza	6,2 m

V 1050

Kg/ml	1,701
Lunghezza	7,5 m

V 1055

Kg/ml	1,242
Lunghezza	7,5 m

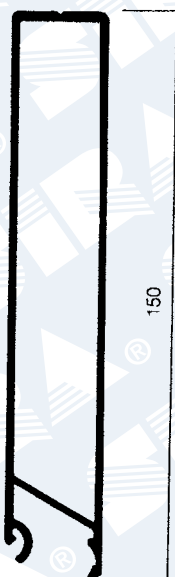
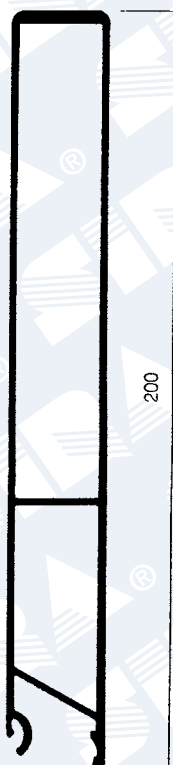

PROFILATI IN ALLUMINIO PER SPONDE, FURGONI E PIANALI

PROFILATI IN ALLUMINIO PER SPONDE

Profili intermedi

V 1043

Kg/ml	2,319
Lunghezza	7,5 m
Lunghezza	6,6 m
Lunghezza	6,2 m

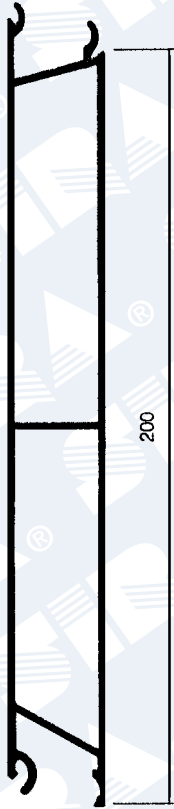

V 1051

Kg/ml	1,761
Lunghezza	7,5 m



V 1048

Kg/ml	1,302
Lunghezza	7,5 m
Lunghezza	6,6 m
Lunghezza	6,2 m



PROFILATI IN ALLUMINIO PER SPONDE, FURGONI E PIANALI

PROFILATI IN ALLUMINIO PER SPONDE

Profili intermedi TIR



V 1047

Kg/ml	2,190
Lunghezza	7,5 m
Lunghezza	6,6 m
Lunghezza	6,2 m



V 1032

Kg/ml	2,389
Lunghezza	7,5 m
Lunghezza	6,6 m
Lunghezza	6,2 m

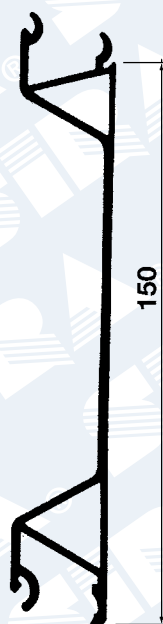

V 1052

Kg/ml	1,667
Lunghezza	7,5 m

Profilo TS TIR concava

V 1057

Kg/ml	2,497
Lunghezza	7,5 m
Lunghezza	6,6 m

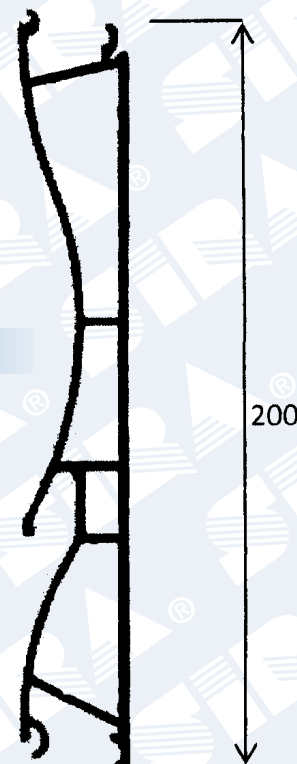

PROFILATI IN ALLUMINIO PER SPONDE, FURGONI E PIANALI

PROFILATI IN ALLUMINIO PER SPONDE

Profili inferiori

V 1045

Kg/ml 2,555
Lunghezza 7,5 m
Lunghezza 6,6 m
Lunghezza 6,2 m

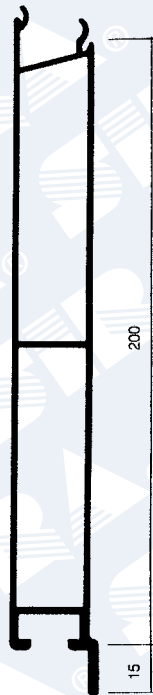

Battuta contraria

V 1049

Kg/ml 2,557
Lunghezza 7,5 m

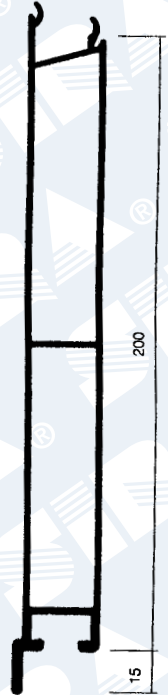

V 1046

Kg/ml 2,575
Lunghezza 7,5 m
Lunghezza 6,6 m
Lunghezza 6,2 m

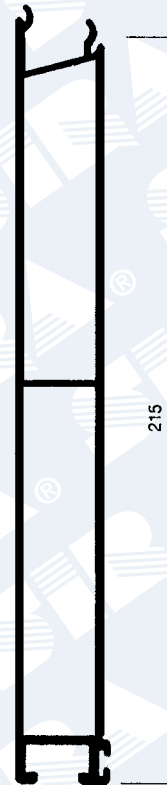

V 1054

Kg/ml 1,996
Lunghezza 7,5 m



T 40050

Guarnizione in gomma di battuta
per profilo V 1046
Vendita a mt



PROFILATI IN ALLUMINIO PER SPONDE, FURGONI E PIANALI

PROFILATI IN ALLUMINIO PER SPONDE

Profili superiori per sponde ribaltabili

V 1076

Kg/ml	2,663
Lunghezza	7,5 m
Lunghezza	6,6 m
Lunghezza	6,2 m

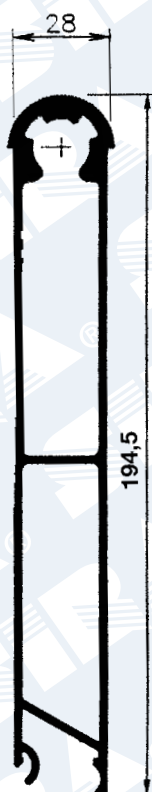

V 1528

Kg/ml	3,408
Lunghezza	7,5 m
Lunghezza	6,6 m
Lunghezza	6,2 m



PROFILATI IN ALLUMINIO PER SPONDE, FURGONI E PIANALI

PROFILATI IN ALLUMINIO PER SPONDE

Profili inferiori per sponde ribaltabili

V 1098

Kg/ml	4,492
Lunghezza	7,5 m
Lunghezza	6,6 m
Lunghezza	6,2 m

V 1075

Kg/ml	2,682
Lunghezza	7,5 m
Lunghezza	6,6 m
Lunghezza	6,2 m

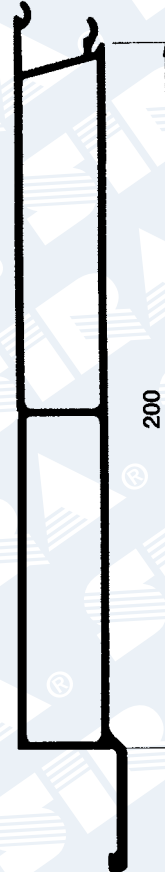
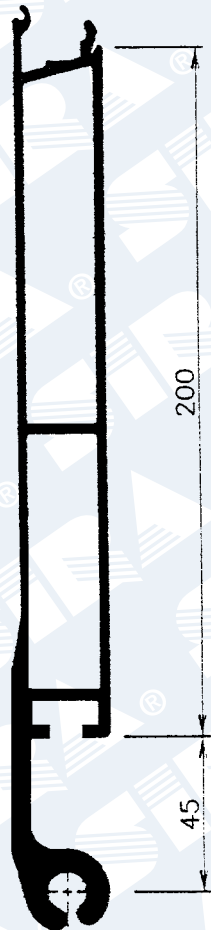

PROFILATI IN ALLUMINIO PER SPONDE, FURGONI E PIANALI

PROFILATI IN ALLUMINIO PER SPONDE

Profili ad incastro per sponde da 25 mm

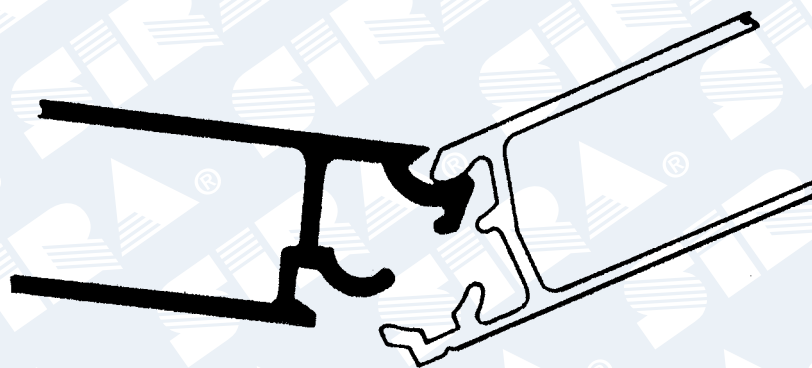

SERIE TR1

Profili superiori

V 1183

Kg/ml	2,425
Lunghezza	7,5 m
Lunghezza	6,6 m
Lunghezza	6,0 m

V 1308

Kg/ml	2,103
Lunghezza	7,5 m

V 1309

Kg/ml	1,617
Lunghezza	7,5 m

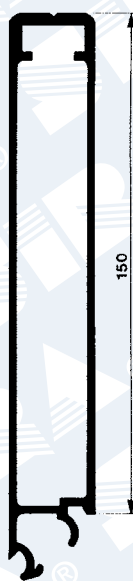
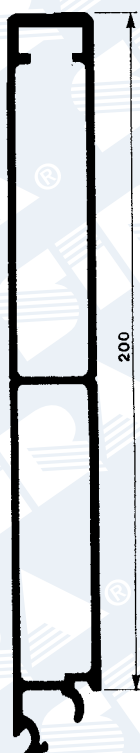

PROFILATI IN ALLUMINIO PER SPONDE, FURGONI E PIANALI

PROFILATI IN ALLUMINIO PER SPONDE

Profili intermedi

V 1186

Kg/ml	2,360
Lunghezza	7,5 m
Lunghezza	6,6 m
Lunghezza	6,0 m

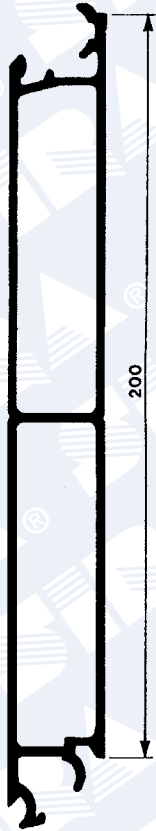

V 1315

Kg/ml	2,063
Lunghezza	7,5 m



V 1307

Kg/ml	1,582
Lunghezza	7,5 m



PROFILATI IN ALLUMINIO PER SPONDE, FURGONI E PIANALI

PROFILATI IN ALLUMINIO PER SPONDE

Profili intermedi TIR

V 1350

Kg/ml	2,417
Lunghezza	7,5 m
Lunghezza	6,6 m
Lunghezza	6,0 m

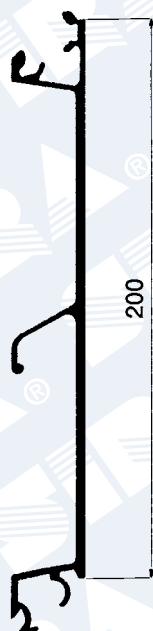

V 1184

Kg/ml	1,898
Lunghezza	7,5 m
Lunghezza	6,6 m
Lunghezza	6,2 m



V 1188

Kg/ml	2,640
Lunghezza	7,5 m
Lunghezza	6,6 m

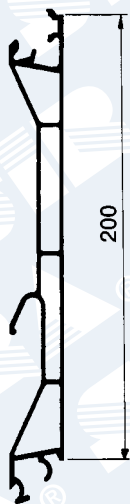

V 1306

Kg/ml	1,822
Lunghezza	7,5 m



PROFILATI IN ALLUMINIO PER SPONDE, FURGONI E PIANALI

PROFILATI IN ALLUMINIO PER SPONDE

Profili inferiori

V 1185

Kg/ml 2,500
Lunghezza 7,5 m
Lunghezza 6,6 m
Lunghezza 6,0 m

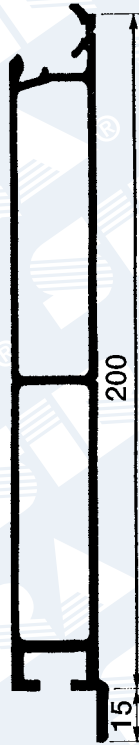

V 1310

Kg/ml 2,160
Lunghezza 7,5 m



V 1187

Kg/ml 1,534
Lunghezza 7,5 m

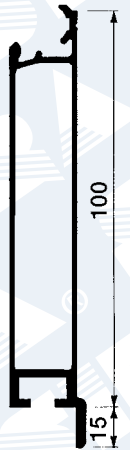

V 1314

Kg/ml 2,822
Lunghezza 7,5 m
Lunghezza 6,6 m

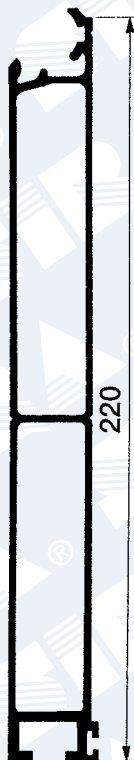

V 1189

Kg/ml 2,832
Lunghezza 7,5 m
Lunghezza 6,6 m

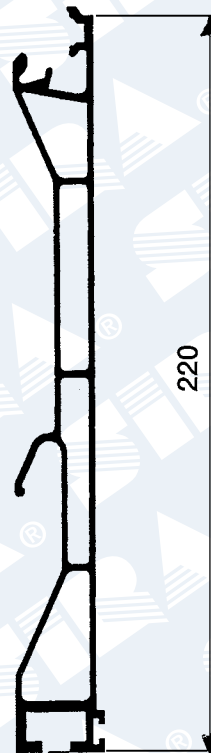

V 1311

Kg/ml 2,751
Lunghezza 7,5 m

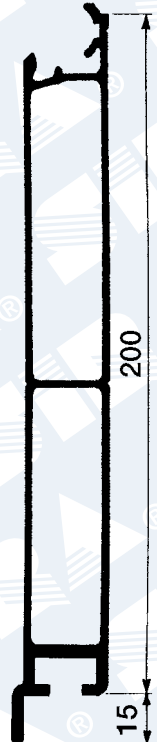

Battuta contraria

PROFILATI IN ALLUMINIO PER SPONDE, FURGONI E PIANALI

PROFILATI IN ALLUMINIO PER SPONDE

Profili per sponde ribaltabili

V 1408

Kg/ml 2,879
Lunghezza 7,5 m
Lunghezza 6,6 m

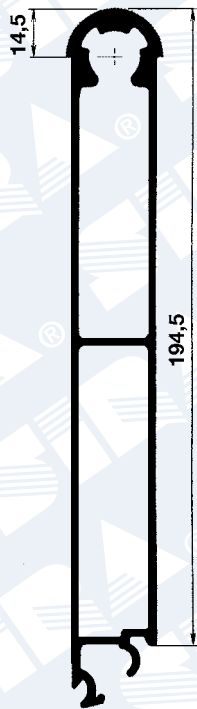

V 1410

Kg/ml 2,656
Lunghezza 7,5 m
Lunghezza 6,6 m

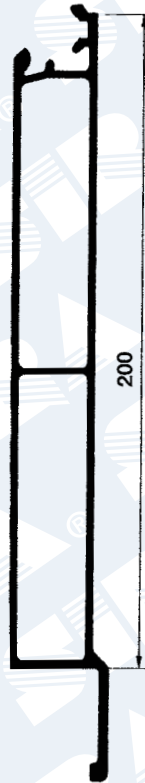

V 1527

Kg/ml 4,617
Lunghezza 7,5 m
Lunghezza 6,6 m

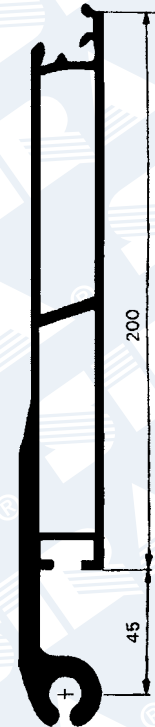

PROFILATI IN ALLUMINIO PER SPONDE, FURGONI E PIANALI

PROFILATI IN ALLUMINIO PER SPONDE

Profili ad incastro per sponde da 25 mm

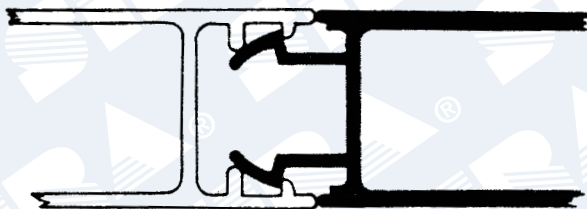

SERIE ALUCAR

Profili superiori

V 1101

Kg/ml 2,260
Lunghezza 7,5 m

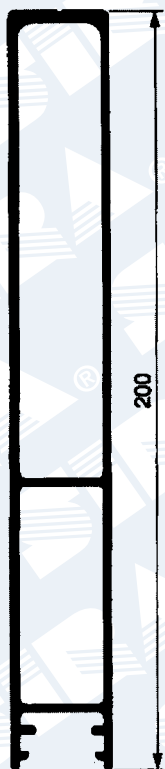

V 1102

Kg/ml 1,699
Lunghezza 7,5 m

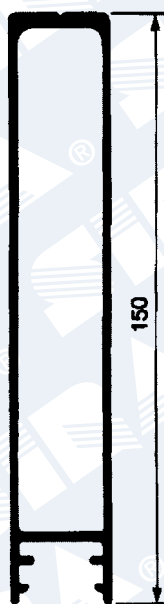

V 1165

Kg/ml 1,240
Lunghezza 7,5 m



PROFILATI IN ALLUMINIO PER SPONDE, FURGONI E PIANALI

PROFILATI IN ALLUMINIO PER SPONDE

Profili intermedi

V 1103

Kg/ml 2,292
Lunghezza 7,5 m

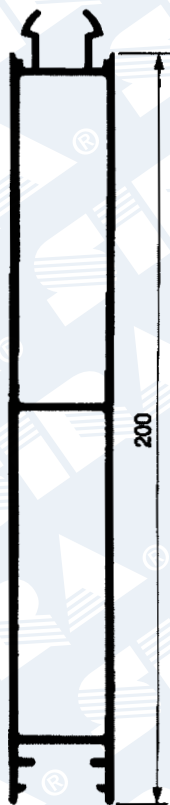

V 1104

Kg/ml 1,731
Lunghezza 7,5 m

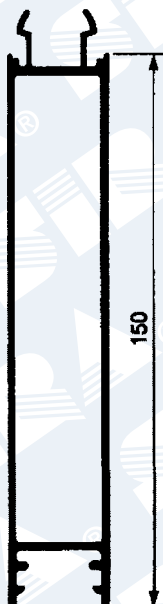

V 1105

Kg/ml 1,272
Lunghezza 7,5 m



PROFILATI IN ALLUMINIO PER SPONDE, FURGONI E PIANALI

PROFILATI IN ALLUMINIO PER SPONDE

Profili intermedi TIR

V 1120

Kg/ml 2,174
Lunghezza 7,5 m

V 1121

Kg/ml 1,796
Lunghezza 7,5 m



PROFILATI IN ALLUMINIO PER SPONDE, FURGONI E PIANALI

PROFILATI IN ALLUMINIO PER SPONDE

Profili inferiori

V 1107

Kg/ml 2,022
Lunghezza 7,5 m

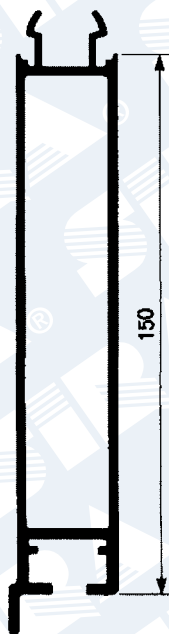

V 1106

Kg/ml 2,583
Lunghezza 7,5 m

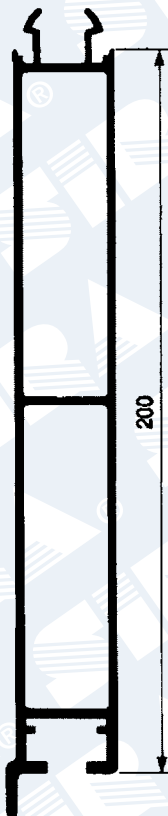

V 1109

Kg/ml 2,511
Lunghezza 7,5 m

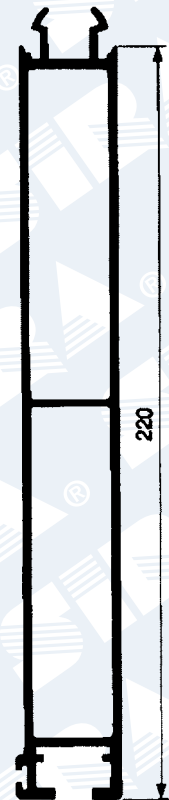

PROFILATI IN ALLUMINIO PER SPONDE, FURGONI E PIANALI

PROFILATI IN ALLUMINIO PER SPONDE

Profili complementari

V 1305

Kg/ml 0,756
Lunghezza 6,0 m

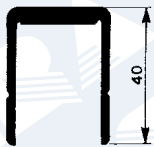

V 1312

Kg/ml 0,918
Lunghezza 6,0 m

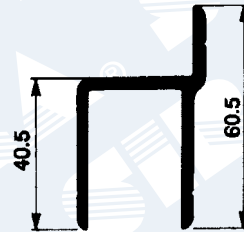

V 1313

Kg/ml 1,009
Lunghezza 6,0 m

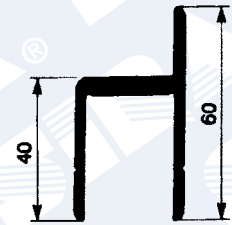

V 1336

Kg/ml 2,109
Lunghezza 6,0 m

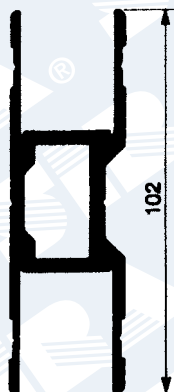

V 1396

Kg/ml 0,823
Lunghezza 6,0 m

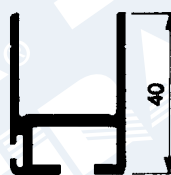

T 40050

Guarnizione in gomma
per profilo V 1396
Vendita a mt



PROFILATI IN ALLUMINIO PER SPONDE, FURGONI E PIANALI

PROFILATI IN ALLUMINIO PER SPONDE

Profili ad incastro per sponde da 40 mm - SERIE TR 5

V 1392

Kg/ml	4,700
Lunghezza	7,5 m
Lunghezza	6,6 m
Lunghezza	6,0 m

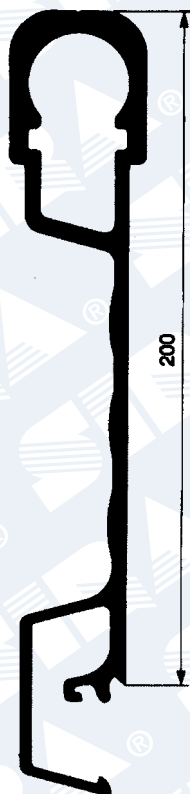

V 1393

Kg/ml	3,966
Lunghezza	7,5 m
Lunghezza	6,6 m



Profili superiori

V 1394

Kg/ml	2,794
Lunghezza	7,5 m
Lunghezza	6,6 m

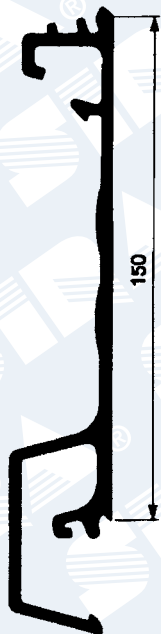

V 1391

Kg/ml	3,340
Lunghezza	7,5 m
Lunghezza	6,6 m
Lunghezza	6,0 m

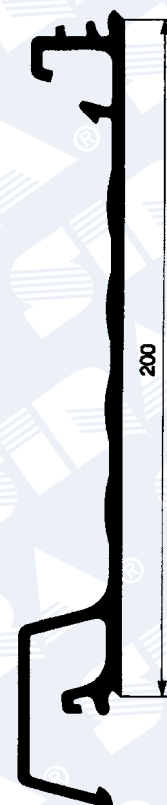

Profili intermedi

PROFILATI IN ALLUMINIO PER SPONDE, FURGONI E PIANALI

PROFILATI IN ALLUMINIO PER SPONDE

Profili inferiori

V 1356

Kg/ml	3,985
Lunghezza	7,5 m
Lunghezza	6,6 m
Lunghezza	6,0 m

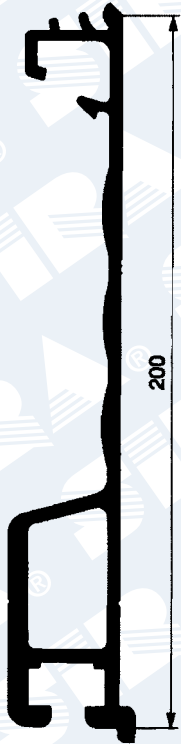

V 1385

Kg/ml	3,970
Lunghezza	7,5 m
Lunghezza	6,6 m
Lunghezza	6,0 m

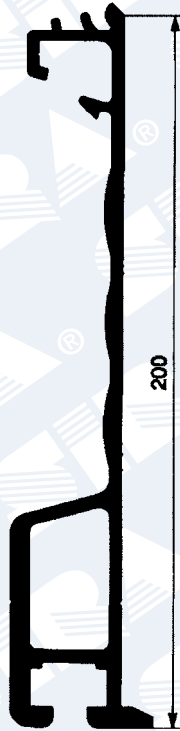

V 1559

Kg/ml	5,313
Lunghezza	7,5 m
Lunghezza	6,6 m
Lunghezza	6,0 m



V 1357

Kg/ml	1,817
Lunghezza	6,0 m

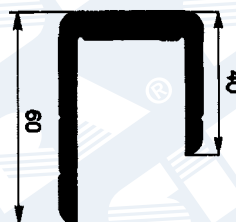

PROFILATI IN ALLUMINIO PER SPONDE, FURGONI E PIANALI

PROFILATI IN ALLUMINIO PER SPONDE

Profili ad incastro per sponde da 30 mm - Serie 5R

V 1190

Kg/ml	4,60
Lunghezza	7,5 m
Lunghezza	6,6 m
Lunghezza	6,0 m

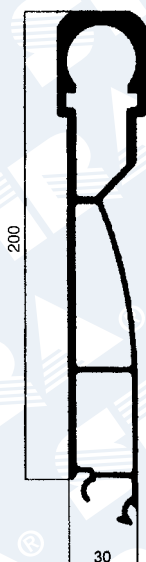

V 1191

Kg/ml	3,20
Lunghezza	7,5 m
Lunghezza	6,6 m
Lunghezza	6,0 m



V 1192

Kg/ml	1,73
Lunghezza	7,5 m
Lunghezza	6,6 m
Lunghezza	6,0 m



V 1193

Kg/ml	5,13
Lunghezza	7,5 m
Lunghezza	6,6 m
Lunghezza	6,0 m



V 1194

Kg/ml	3,80
Lunghezza	7,5 m
Lunghezza	6,6 m
Lunghezza	6,0 m

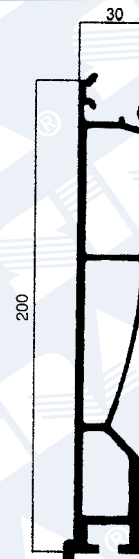

PROFILATI IN ALLUMINIO PER SPONDE, FURGONI E PIANALI

PROFILATI IN ALLUMINIO PER SPONDE

Profili ad incastro Viberti per sponde da 25 mm

V 10290

Kg/ml 2,770
Lunghezza 3175 mm

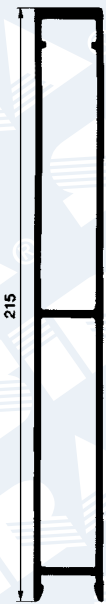

V 10291

Kg/ml 2,600
Lunghezza 3175 mm

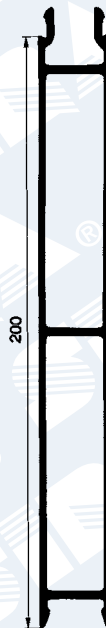

V 10292

Kg/ml 2,050
Lunghezza 3175 mm

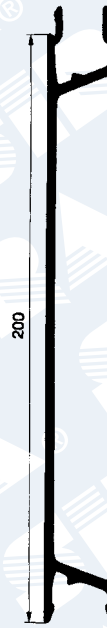

V 10293

Kg/ml 2,775
Lunghezza 3175 mm

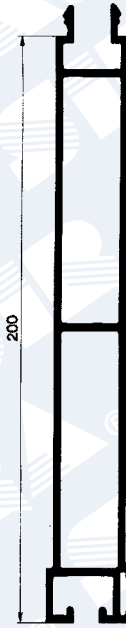

V 10296

Kg/ml 2,450
Lunghezza 3175 mm

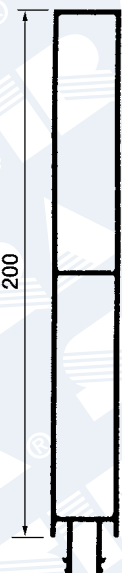

V 10297

Kg/ml 2,300
Lunghezza 3175 mm

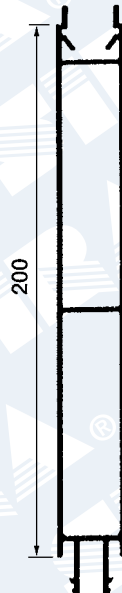

V 10298

Kg/ml 2,090
Lunghezza 3175 mm

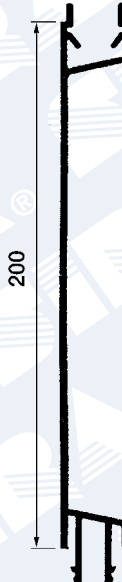

V 10299

Kg/ml 2,750
Lunghezza 3175 mm



PROFILATI IN ALLUMINIO PER SPONDE, FURGONI E PIANALI

PROFILATI IN ALLUMINIO PER SPONDE

Profili ad incastro Cardi per sponde da 25 mm

V 10270

Kg/ml 2,400
Lunghezza 3250 mm

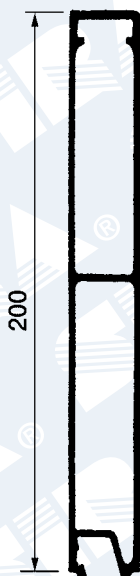

V 10271

Kg/ml 2,500
Lunghezza 3250 mm

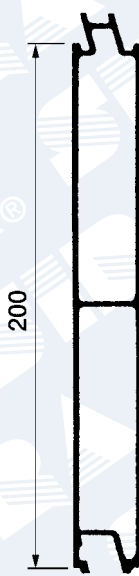

V 10272

Kg/ml 2,200
Lunghezza 3250 mm

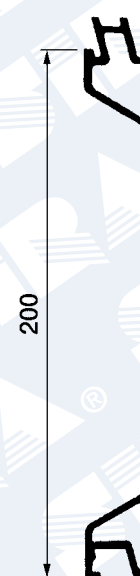

V 10280

Kg/ml 3,200
Lunghezza 3250 mm

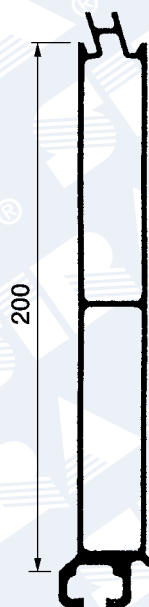

V 10273

Kg/ml 2,700
Lunghezza 3250 mm

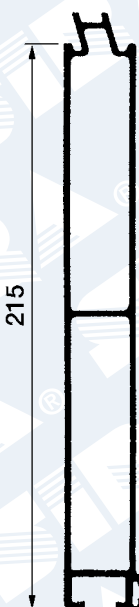

V 10274

Kg/ml 2,600
Lunghezza 3250 mm

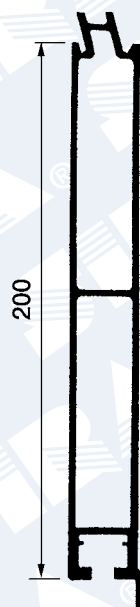

PROFILATI IN ALLUMINIO PER SPONDE, FURGONI E PIANALI

PROFILATI IN ALLUMINIO PER CENTINATURE

V 1143

Kg/ml	1,032
Lunghezza	7,5 m
Lunghezza	6,6 m
Lunghezza	6,0 m
Lunghezza	4,5 m

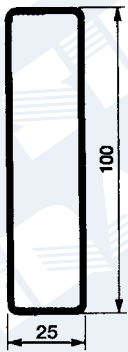

V 1341

Kg/ml	1,366
Lunghezza	7,5 m



V 9184

Kg/ml	1,050
Lunghezza	7,5 m
Lunghezza	6,6 m
Lunghezza	6,0 m
Lunghezza	4,6 m

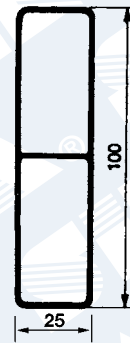

V 9185

Kg/ml	1,903
Lunghezza	7,5 m
Lunghezza	6,6 m
Lunghezza	6,0 m

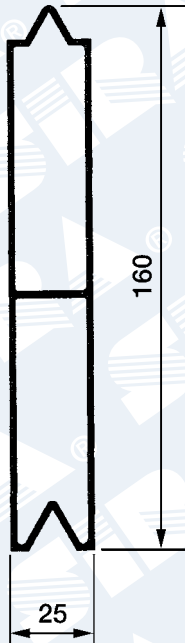

V 1359

Kg/ml	1,617
Lunghezza	7,5 m
Lunghezza	6,6 m
Lunghezza	6,0 m



PROFILATI IN ALLUMINIO PER SPONDE, FURGONI E PIANALI

Monoprofilati per sponde

V 9181

Kg/ml 2,735
Lunghezza 7,5 m

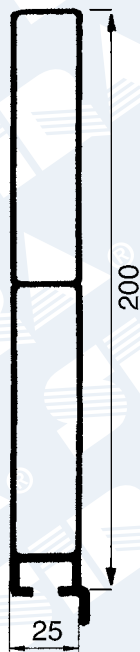

V 1997

Kg/ml 6,791
Lunghezza 7,5 m
Lunghezza 6,6 m
Lunghezza 6,0 m

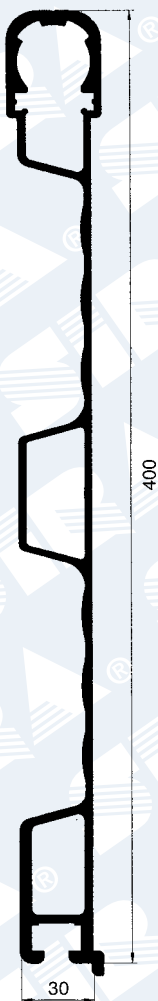

V 5059

Kg/ml 4,596
Lunghezza 7,5 m
Lunghezza 6,6 m
Lunghezza 6,0 m
Lunghezza 4,6 m



PROFILATI IN ALLUMINIO PER SPONDE, FURGONI E PIANALI

Monoprofilati per sponde da 25 mm

V 1402

Kg/ml	4,234
Lunghezza	6,0 m
Lunghezza	6,6 m
Lunghezza	7,5 m

V 5058

Kg/ml	4,137
Lunghezza	4,5 m
Lunghezza	6,0 m
Lunghezza	6,6 m
Lunghezza	7,5 m

V 1529

Kg/ml	4,042
Lunghezza	4,5 m
Lunghezza	6,0 m
Lunghezza	6,6 m
Lunghezza	7,5 m

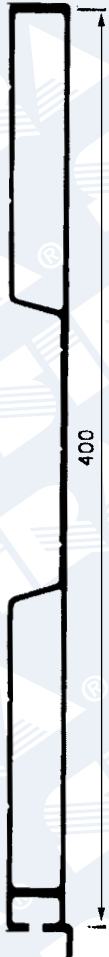

PROFILATI IN ALLUMINIO PER SPONDE, FURGONI E PIANALI

PROFILATI IN ALLUMINIO PER FURGONATURE

Profili per l'allestimento di furgonature

Profili superiori

V 2291

Kg/ml 1,274
Lunghezza 7,5 m



Traversa tetto

V 2287

Kg/ml 0,872
Lunghezza 7,5 m

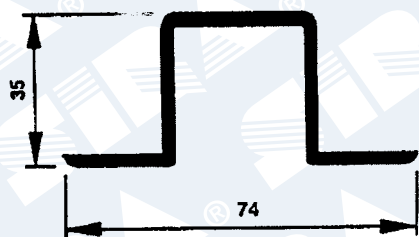

V 2302

Kg/ml 1,958
Lunghezza 7,5 m

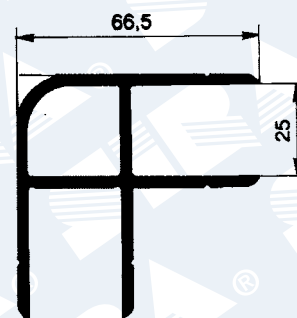

Profilo inferiore

V 2298

Kg/ml 1,577
Lunghezza 7,5 m

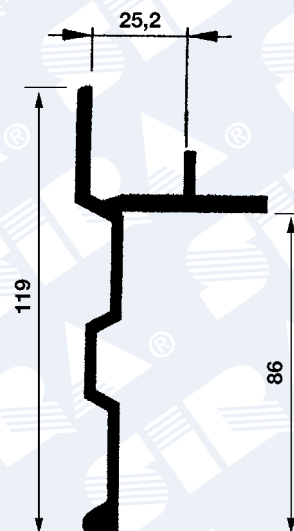

PROFILATI IN ALLUMINIO PER SPONDE, FURGONI E PIANALI

PROFILATI IN ALLUMINIO PER FURGONATURE

Profili per l'allestimento di furgonature e isothermici

Profili angolari

V 2295

Kg/ml 0,988
Lunghezza 7,5 m

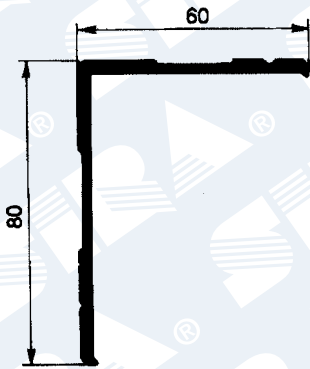

V 9186

Kg/ml 0,660
Lunghezza 7,5 m

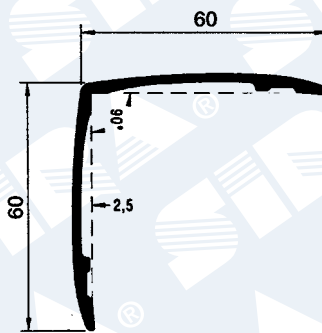

V 2362

Kg/ml 0,645
Lunghezza 7,5 m

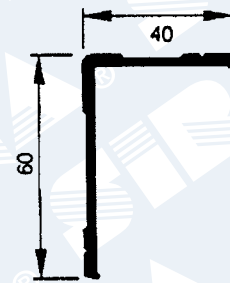

Profili per gocciolatoi

VMM 2550

Gr/ml 238
Lunghezza 6,0 m

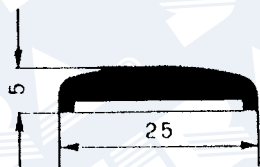

VUNG 2550

Gr/ml 140
Lunghezza 6,0 m

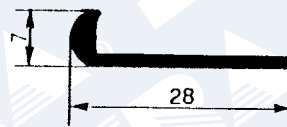

VGOC 2320

Gr/ml 265
Lunghezza 6,0 m

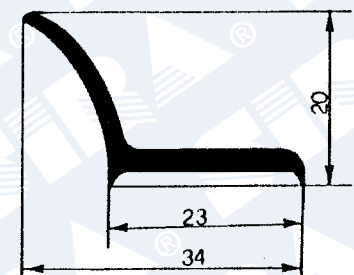

PROFILATI IN ALLUMINIO PER SPONDE, FURGONI E PIANALI

PROFILATI IN ALLUMINIO PER FURGONATURE

Profili per l'allestimento di furgonature

Profili battuta porta

V 2288

Kg/ml 1,409
Lunghezza 7,5 m

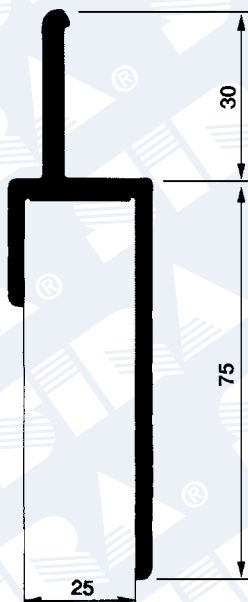

V 2289

Kg/ml 1,107
Lunghezza 7,5 m

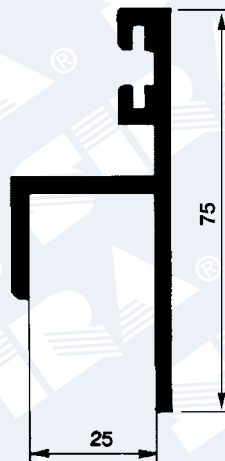

V 10310

Guarnizione in gomma
per articolo V 2289
Vendita a mt



Profilo parete

V 2297

Kg/ml 1,458
Lunghezza 7,5 m

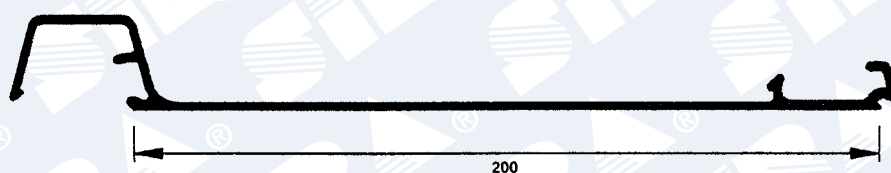

PROFILATI IN ALLUMINIO PER SPONDE, FURGONI E PIANALI

PROFILATI IN ALLUMINIO PER FURGONATURE

Profili per l'allestimento di furgonature

V 9176

Kg/ml 1,316

Lunghezza 7,5 m

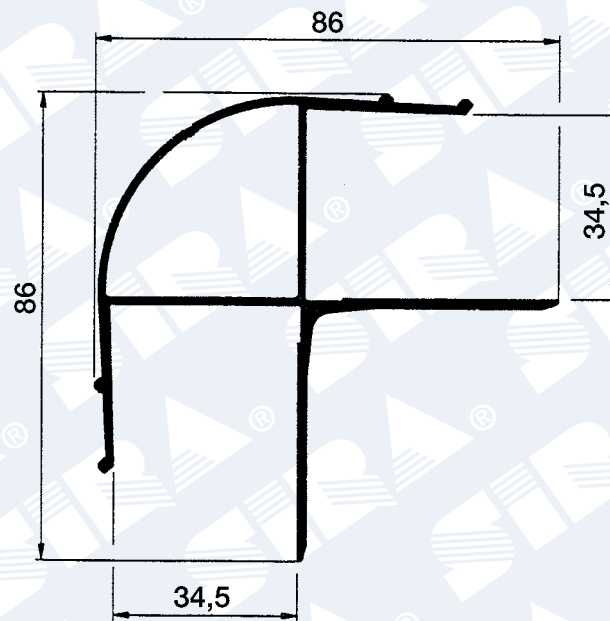

G 20465

Fusione d'angolo
per articolo V 9176

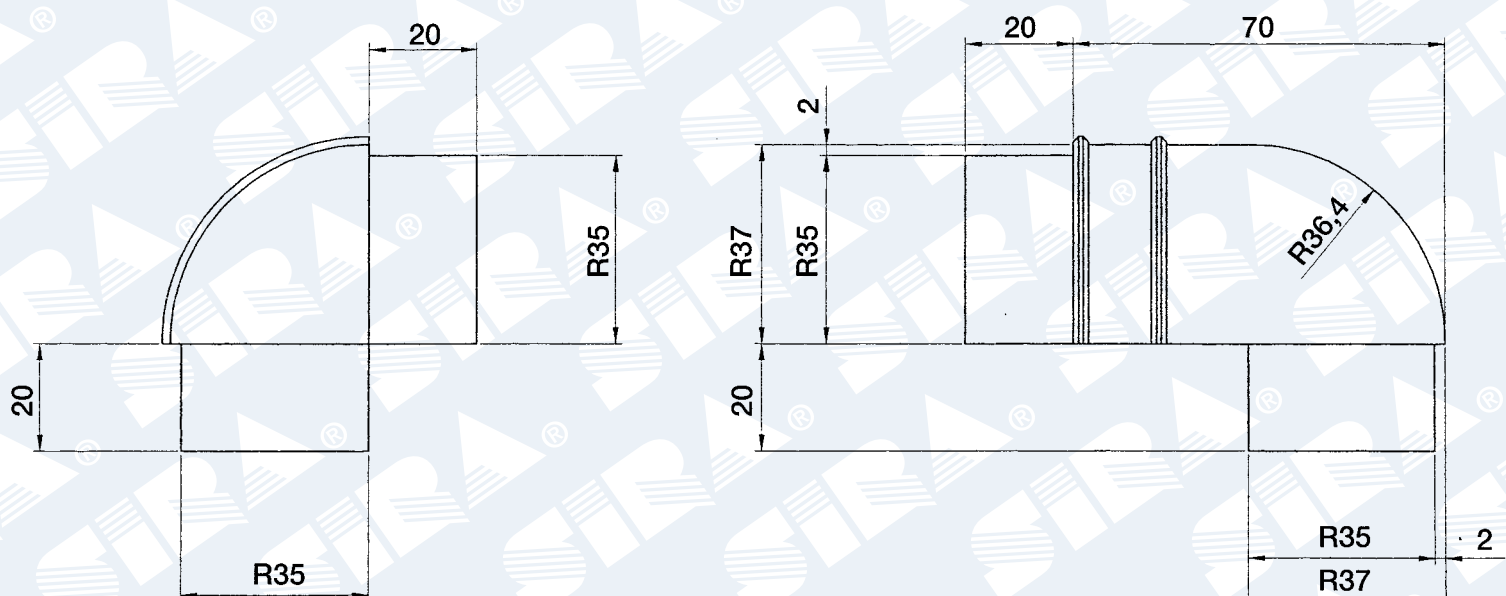

PROFILATI IN ALLUMINIO PER SPONDE, FURGONI E PIANALI

PROFILATI IN ALLUMINIO PER FURGONATURE

Profili per l'allestimento di furgonature

V 9177

Kg/ml 1,314
Lunghezza 7,5 m

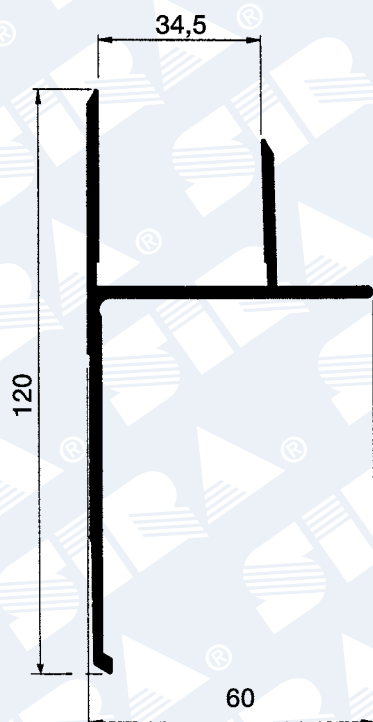

V 9179

Kg/ml 1,428
Lunghezza 7,5 m

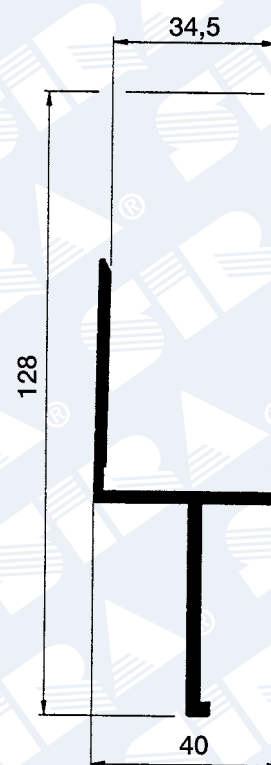

V 9178

Kg/ml 1,314
Lunghezza 7,5 m

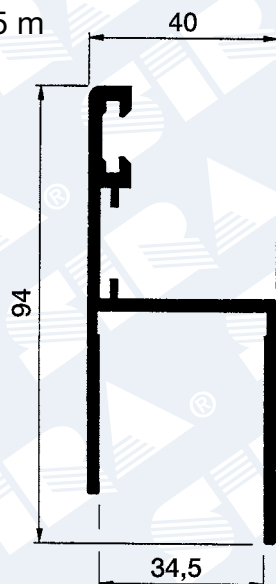

V 10310

Guarnizione in gomma
per articolo V 9178
Vendita a mt



PROFILATI IN ALLUMINIO PER SPONDE, FURGONI E PIANALI

PROFILATI IN ALLUMINIO PER FURGONATURE

Profili per l'allestimento di furgonature e isothermici

V 9187

Kg/ml 2,44
Lunghezza 7,5 m



V 9188

Kg/ml 2,18
Lunghezza 7,5 m



PROFILATI IN ALLUMINIO PER SPONDE, FURGONI E PIANALI

PROFILATI IN ALLUMINIO PER PIANALI

Profili per pianali

V 3047

Kg/ml 2,755
Lunghezza 7,5 m

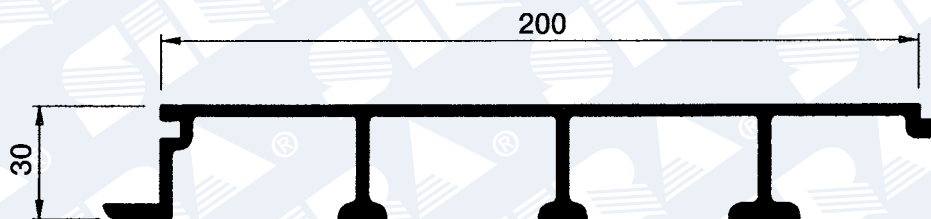

V 3080

Kg/ml 2,857
Lunghezza 7,5 m

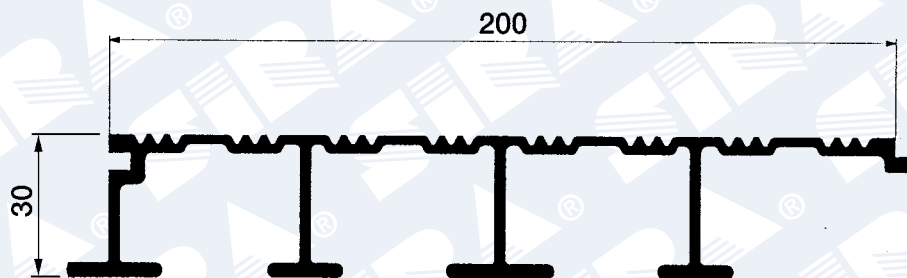

V 3008

Kg/ml 3,850
Lunghezza 7,5 m

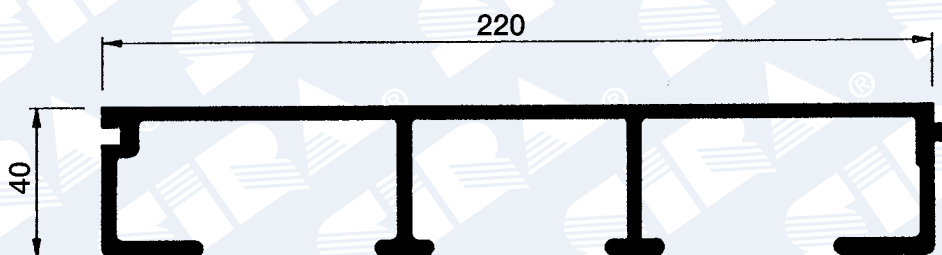

V 3009

Kg/ml 3,900
Lunghezza 7,5 m

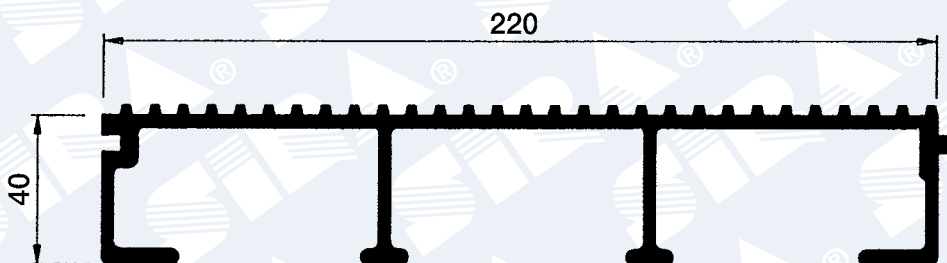

PROFILATI IN ALLUMINIO PER SPONDE, FURGONI E PIANALI

PROFILATI IN ALLUMINIO PER PARACICLI

Profili paracicli

V 7271

Kg/ml 1,080
Lunghezza 7,5 m



V 7270

Kg/ml 1,350
Lunghezza 6,0 m

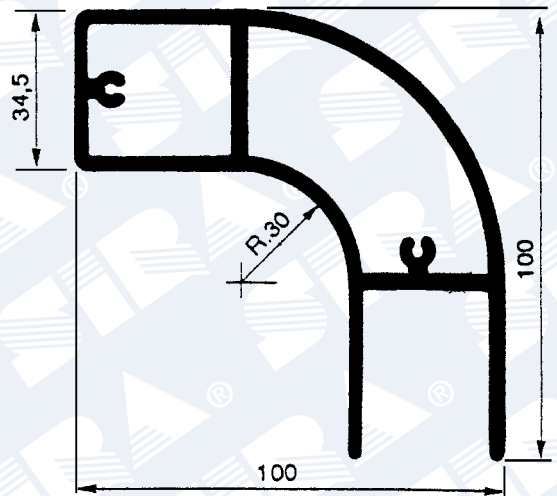

V 9182

Kg/ml 1,485
Lunghezza 7,5 m

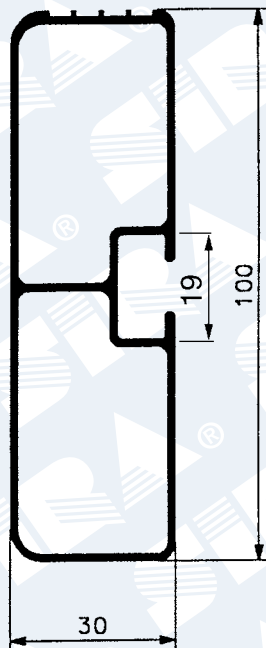

V 9183

Kg/ml 2,190
Lunghezza 6,0 m

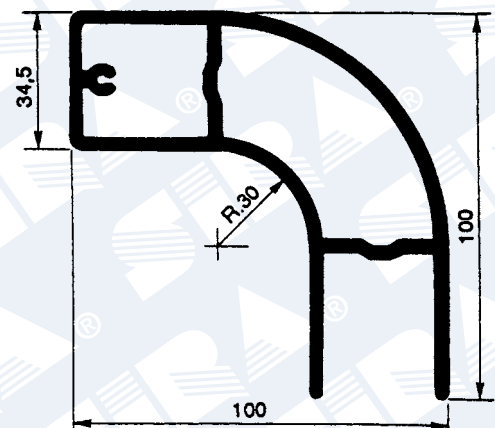

PROFILATI IN ALLUMINIO PER SPONDE, FURGONI E PIANALI

PROFILATI IN ALLUMINIO PER PARACICLI

Profili paracicli

V 9091

Kg/ml 2,312
Lunghezza 7,0 m

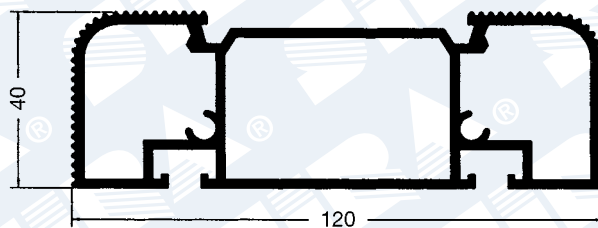

V 9090

Kg/ml 2,371
Lunghezza 5,0 m

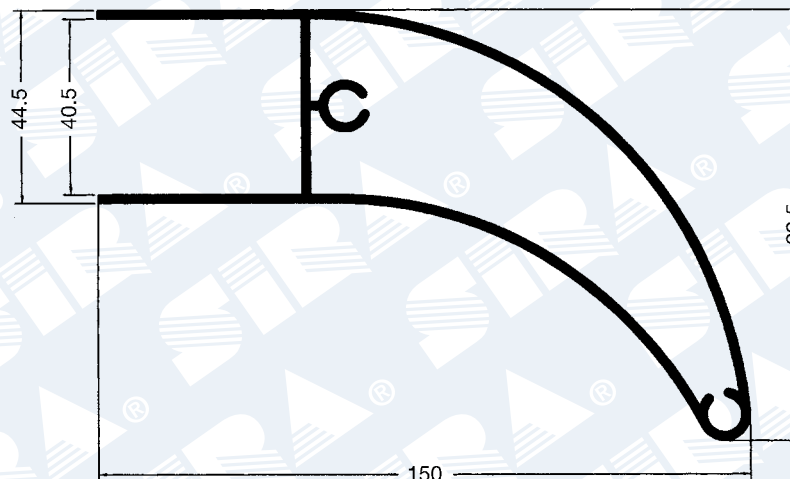

PROFILATI IN ALLUMINIO PER SPONDE, FURGONI E PIANALI

PROFILATI IN ALLUMINIO PER CENTINATURE ALLA FRANCESE

V 9134

Kg/ml 2,120
Lunghezza 7,5 m

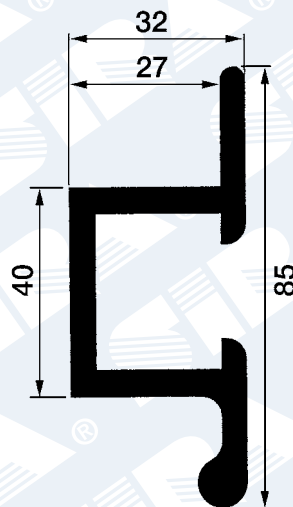

PROFILO INFERIORE
PER AGGANCIAMENTO TELO

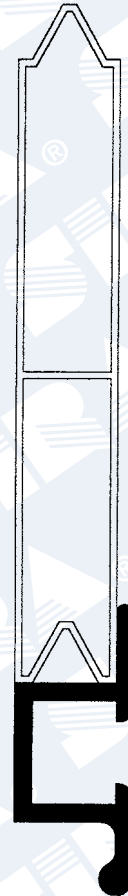

V 10320

Guarnizione in gomma per profilo
V 9134 vendita a mt

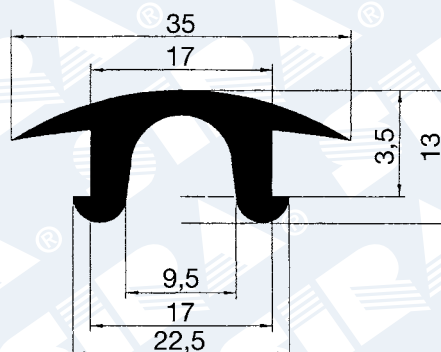

PROFILATI IN ALLUMINIO PER SPONDE, FURGONI E PIANALI

PROFILATI IN ALLUMINIO PER CENTINATURE ALLA FRANCESE

V 9174

Kg/ml 0,962
Lunghezza 7,5 m

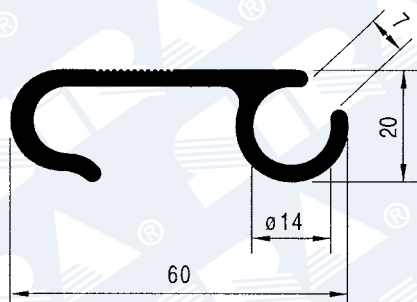

PROFILO AGGANCIAMENTO TELO

V 9175

Kg/ml 0,873
Lunghezza 7,5 m

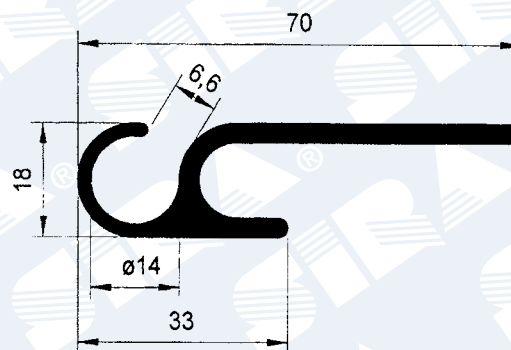

PROFILO AGGANCIAMENTO TELO

V 9133

Kg/ml 1,647
Lunghezza 7,5 m

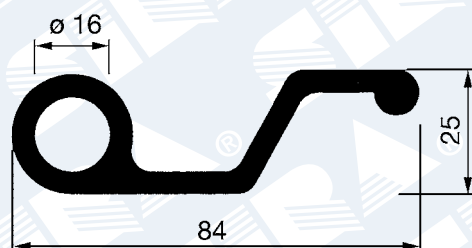

PROFILO TENSIONATORE

V 9135

Kg/ml 2,746
Lunghezza 7,5 m

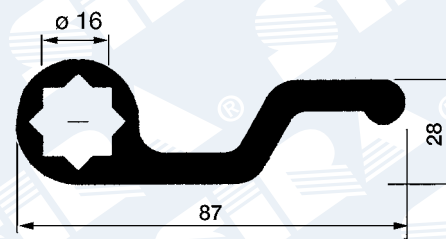

PROFILATI IN ALLUMINIO PER SPONDE, FURGONI E PIANALI

LAMIERE IN ALLUMINIO

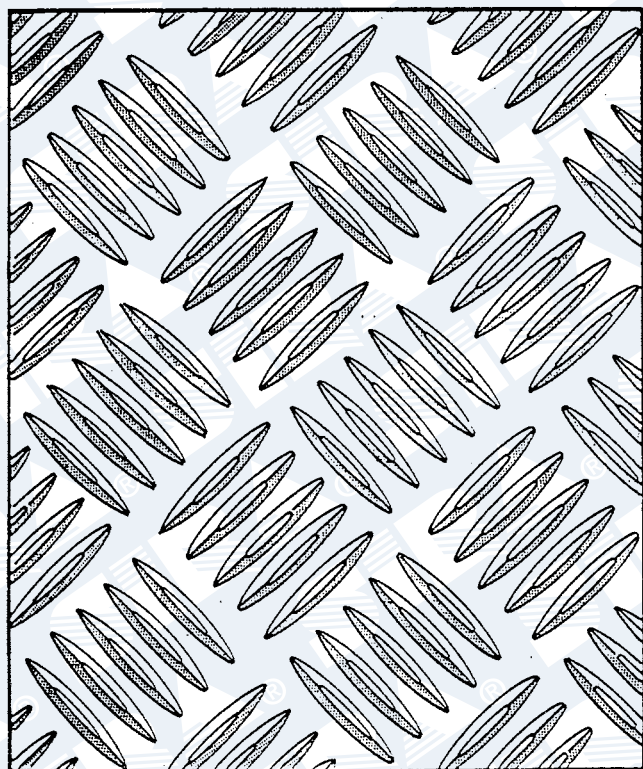

Lamiera mandorlata

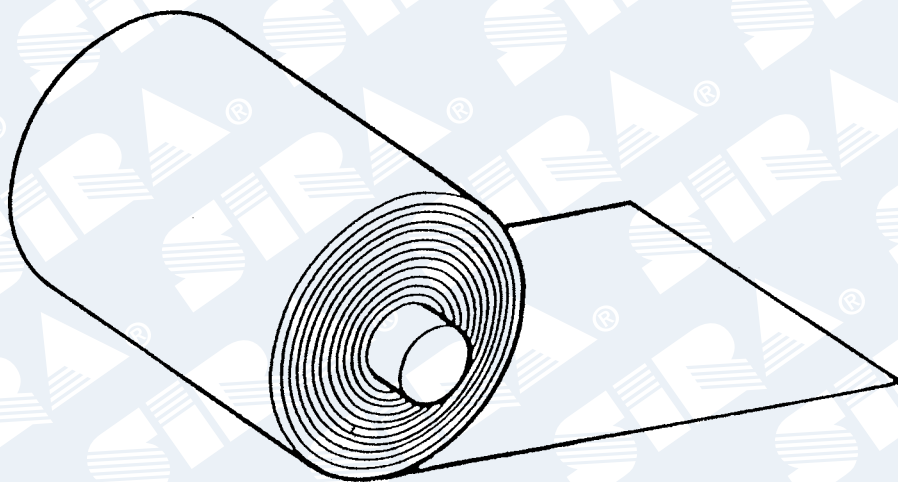

Lamiera in cois

Tipo	Codice	Dimensioni mm			Peso Indicativo	Legg
		Spessore	Altezza	Lunghezza		
Lamiera mandorlata	V 5050 102020	2*	1000	2000	12 kg	All. 99,5-1200 F
Lamiera mandorlata	V 5050 102025	2,5*	1000	2000	15 kg	All. 99,5-1200 F
Lamiera mandorlata	V 5050 102030	3*	1000	2000	18 kg	All. 99,5-1200 F
Lamiera mandorlata	V 5050 122520	2*	1250	2500	20 kg	All. 99,5-1200 F
Lamiera mandorlata	V 5050 122525	2,5*	1250	2500	25 kg	All. 99,5-1200 F
Lamiera mandorlata	V 5050 122530	3*	1250	2500	29 kg	All. 99,5-1200 F
Lamiera mandorlata	V 5050 153030	3*	1500	3000	40 kg	All. 99,5-1200 F
Lamiera mandorlata	V 5050 214520	2*	2100	4500	62 kg	All. 99,5-1200 F
Lamiera liscia cois	V 10210	1	2550	a metratura	3 kg/mq	Duralinox 3003 H16

* Senza mandorla